

Article number: 51030454000010

Description: Vibration damper GS-M2  
100x45x2000-15, NR shore 57

## Measures

---

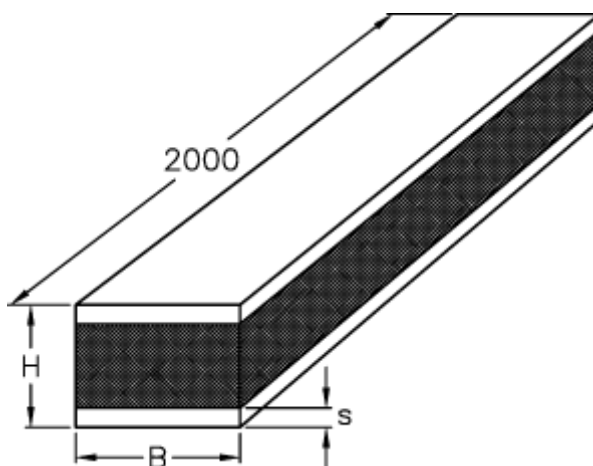

B = 100  
H = 45  
S = 15